



# DIMENSIONS™

71264



THE LEGO  
**BATMAN**  
MOVIE



[LEGO.com/DIMENSIONS](https://www.lego.com/DIMENSIONS)

This device complies with part 15 of the FCC Rules. Operation is subject to the following two conditions: (1) This device may not cause harmful interference, and (2) this device must accept any interference received, including interference that may cause undesired operation.

This device should be installed and operated with a minimum distance of 20 cm to your body.

NOTE: This equipment has been tested and found to comply with the limits for a Class B digital device, pursuant to part 15 of the FCC Rules. These limits are designed to provide reasonable protection against harmful interference in a residential installation. This equipment generates, uses and can radiate radio frequency energy and, if not installed and used in accordance with the instructions, may cause harmful interference to radio communications. However, there is no guarantee that interference will not occur in a particular installation. If this equipment does cause harmful interference to radio or television reception, which can be determined by turning the equipment off and on, the user is encouraged to try to correct the interference by one or more of the following measures:

- Reorient or relocate the receiving antenna.
- Increase the separation between the equipment and receiver.
- Connect the equipment into an outlet on a circuit different from that to which the receiver is connected.
- Consult the dealer or an experienced radio/TV technician for help.

Caution: changes or modifications not expressly approved by the party responsible for compliance could void the user's authority to operate the equipment.

This device complies with Industry Canada license-exempt RSS standard(s). Operation is subject to the following two conditions: (1) this device may not cause interference, and (2) this device must accept any interference, including interference that may cause undesired operation of the device.

Le présent appareil est conforme aux CNR d'Industrie Canada applicables aux appareils radio exempts de licence. L'exploitation est autorisée aux deux conditions suivantes : (1) l'appareil ne doit pas produire de brouillage, et (2) l'utilisateur de l'appareil doit accepter tout brouillage radioélectrique subi, même si le brouillage est susceptible de en compromettre le fonctionnement.



- EN Protect the environment by not disposing of this product with your household waste (2012/19/EU). Check with your local authority for recycling advice and facilities.
- DE Schützen Sie die Umwelt und entsorgen Sie dieses Produkt nicht mit Ihrem Hausmüll (2012/19/EU). Informationen zu Recycling-Möglichkeiten erhalten Sie bei den örtlichen Behörden.
- FR Protégez l'environnement : ne jetez pas ce produit avec vos autres déchets ménagers (Directive européenne 2012/19/UE). Contactez les autorités locales pour obtenir des informations sur le recyclage et connaître les points de collecte.
- IT Proteggi l'ambiente! Non smaltire questo prodotto con i rifiuti domestici (2012/19/UE). Per consulenza sul riciclaggio dei rifiuti e le strutture di riciclaggio, rivolgersi alle proprie autorità locali.
- NL Bescherm het milieu: gooi dit product niet samen met het andere huisvuil weg (2012/19/EU). Raadpleeg de plaatselijke instanties voor locaties van milieustations en advies over hergebruik.
- ES Proteja el medio ambiente no deshaciéndose de este producto junto con sus residuos domésticos (2012/19/UE). Solicite a su autoridad local consejos e información sobre instalaciones de reciclado.
- DA Beskyt miljøet! Smid ikke dette produkt ud sammen med husholdningsaffaldet (2012/19/EU). Få vejledning om genbrug og genbrugsstationer hos din kommune.
- IS Stuðlið að verndun umhverfis með því að farga þessari vöru ekki með heimilissorpi (2012/19/ESB). Leitið upplýsinga um endurvinnslu- og förgunarstaði hjá staðaryfirvöldum.
- FI Tämä tuote on hävitettävä ympäristönsuojelun vuoksi asianmukaisesti talousjätteistä erillään (2012/19/EU). Tietoja keräyspisteiden sijainnista saa kunnan tai kaupungin teknisestä virastosta.
- SV Skydda miljön genom att inte kasta denna produkt bland ditt hushållsavfall (2012/19/EU). Kontakta din kommun för frågor om återvinning och miljöstationer.
- NO Beskytt miljøet. Ikke kast dette produktet i husholdningsavfallet (2012/19/EU). Kontakt kommunen for veiledning om gjenbruk og miljøstasjoner.
- PT Proteja o ambiente não eliminando este produto com o seu lixo doméstico (2012/19/UE). Consulte as autoridades locais para informação sobre reciclagem e sistemas de recolha.
- EL Προστατέψτε το περιβάλλον. Μην πετάτε αυτό το προϊόν μαζί με τα συνηθισμένα οικιακά απορρίμματα (2012/19/ΕΕ). Επικοινωνήστε με τις τοπικές αρχές σχετικά με συμβουλές και εγκαταστάσεις ανακύκλωσης.
- JA 環境保護のため、本製品は家庭ごみとは別に処分してください(2012/19/EU)。リサイクルに関する指示や施設については、お住まいの地方自治体にお問い合わせください。
- ZH 注意保护环境，请勿将本产品与家庭垃圾一起丢弃处理(2012/19/EU)。请咨询您当地相关部门，了解回收设施与回收建议
- KO 환경 보호를 위해 이 제품을 생활폐기물과 함께 버리지 마십시오(2012/19/EU)。재활용 방법 및 시설에 관한 사항은 현지 관계 당국에 문의하십시오。
- RU Защищайте окружающую среду, не утилизируйте этот продукт вместе с бытовым мусором (директива 2012/19/EU). Осведомитесь у местных органов власти о правилах вторичной переработки и утилизации таких отходов.
- PL Chronić środowisko — nie wyrzucaj tego produktu razem z odpadami z gospodarstwa domowego (2012/19/EU). W celu uzyskania informacji dotyczących recyklingu i miejsc składowania zużytego sprzętu należy się skontaktować z lokalnymi władzami.
- CZ Nevyhazujte tento produkt do domácího odpadu, chraňte životní prostředí (2012/19/EU). Zjistěte si prosím u místních úřadů možnosti recyklace a dostupná zařízení.



- SK Nevyhadzujte tento produkt do domáceho odpadu, chráňte životné prostredie (2012/19/EU). Zistite si prosím na miestnych úradoch možnosti recyklácie a dostupné zariadenia.
- HU Környezetét óvja, ha ettől a terméktől nem a háztartási hulladékkal együtt válik meg (2012/19/EU). Érdeklődjék a lakóhelyéhez közel eső hatóságnál az újrahasznosítás módjáról és lehetőségeiről.
- UA Допоможіть захистити довкілля: не утилізуйте цей виріб разом із побутовим сміттям (2012/19/EU). Вказівки з утилізації та відомості про пункти прийому з'ясуйте в місцевих компетентних органів.
- HR Zaštitite okoliš tako da ovaj proizvod ne odložite u otpad zajedno s kućanskim otpadom (2012/19/EU). Od lokalnih vlasti zatražite savjet ili informacije o pogonima za recikliranje.
- SR Zаштитите животну средину тако што нећете одлагати овај производ са кућним отпадом (2012/19/EU). Обратите се локалној овлашћеној служби да бисте добили савете о рециклирању и сазнали о објектима за рециклажу.
- MK Zаштитете ја околината така што нема да се ослободите од производот со домашниот отпад (2012/19/EU). Консултирајте се со локалните власти за да дознаете за советите и објектите за рециклирање.
- SL Zaščitite okolje! Okolje varujte tako, da tega izdelek ne zavržete skupaj z gospodinjiskimi odpadki (2012/19/EU). Pri krajevni upravi preverite, kakšne možnosti in kateri obrati za recikliranje obstajajo v vaši okolici.
- RO Protejați mediul înconjurător și nu vă debarasați de acest produs împreună cu deșeurile menajere (2012/19/UE). Consultați autoritățile locale pentru îndrumări și facilități de reciclare.
- BG Защитете околната среда и не изхвърляйте този продукт заедно с битовите си отпадъци (2012/19/EC). Свържете се с местните власти относно съвети и съоръжения за рециклиране.
- LV Lai saudzētu vidi, neizmetiet šo izstrādājumu kopā ar sadzīves atkritumiem (2012/19/ES). Vērsieties vietējās varas iestādēs, lai noskaidrotu, kur un kā tas nododams pārstrādei.
- ET Keskkonda saate kaitsta nii, et ei kõrvalda seda toodet koos olmejäätmetega (2012/19/EL). Nõuandeid toote taaskasutusse võtmise ja ümbertöötlemispunktide kohta saate asjaomaselt kohalikult asutuselt.
- LT Saugokite aplinką: neišmeskite šio produkto su buitinėmis atliekomis (2012/19/ES). Patarimų, kaip ir kur rūšiuoti šiukšles, teiraukitės vietos valdžios įstaigose.
- TR Bu ürünü, evsel atıklarla birliktе atmayarak çevreyi koruyun (2012/19/EU). Geri dönüşüm tavsiyeleri ve tesisler hakkında bilgi için yerel yönetimle iletişime kurun.
- AR استشر السلطة المحلية للحصول على ساهم في حماية البيئة عن طريق عدم التخلص من هذا المنتج مع المخلفات المنزلية استشر السلطة المحلية للحصول على (2012/19/EU)
- ID Jagalah lingkungan dengan tidak membuang produk ini bersama sampah rumah tangga Anda (2012/19/EU). Periksa peraturan pemerintah setempat tentang saran dan fasilitas daur ulang.
- MS Lindungi persekitaran dengan tidak melupuskan produk ini bersama dengan sisa isi rumah anda (2012/19/EU).Rujuk pihak berkuasa tempatan anda bagi nasihat dan kemudahan kitar semula.

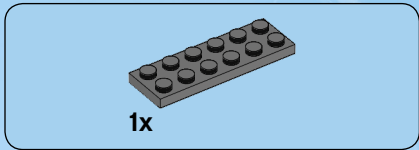
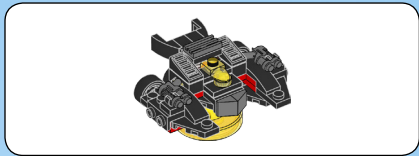

1x

1

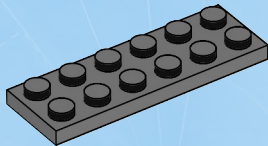



2x

2

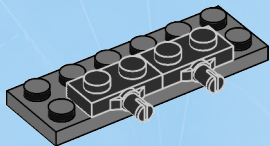

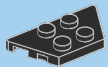

1x

3

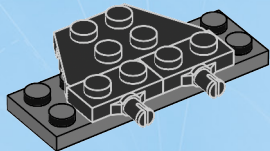



1x



2x

4

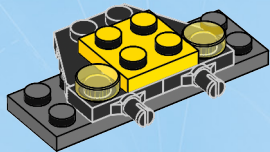





1x

5

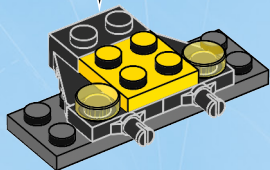
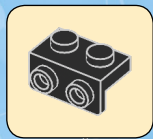

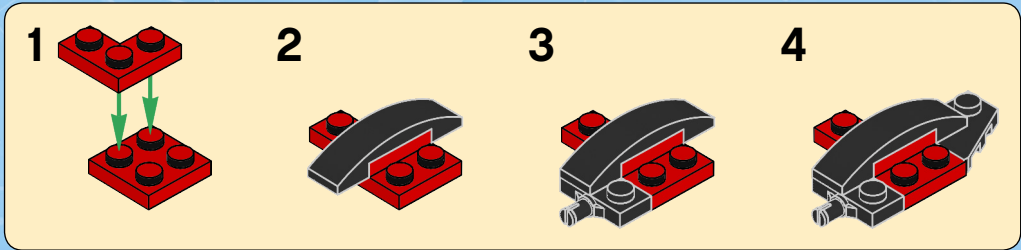
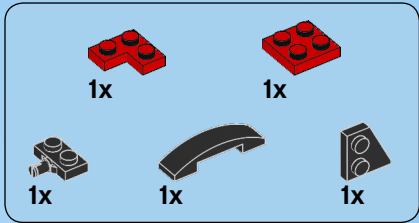

6

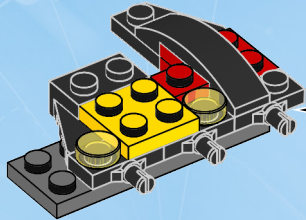

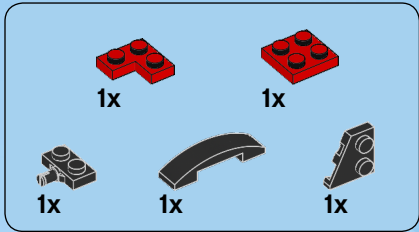

7

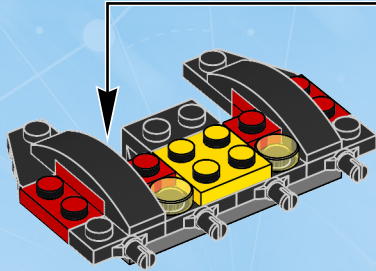
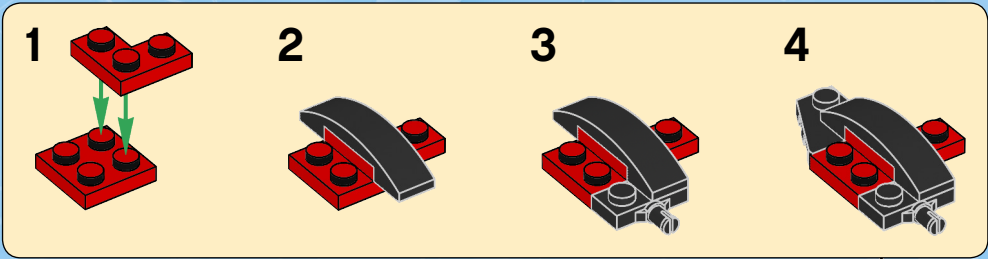



2x

8

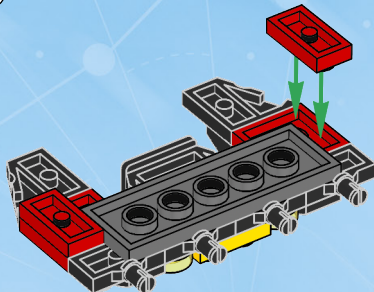
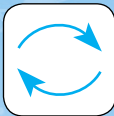



1x



1x

9

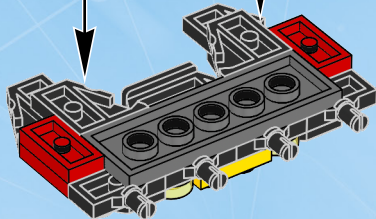
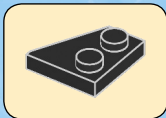
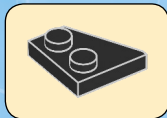



2x

10

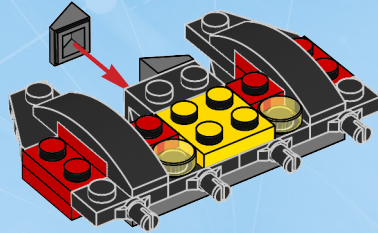

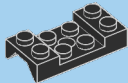

1x



1x

11

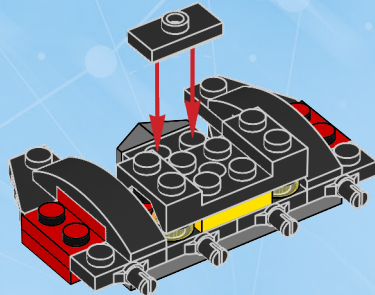



1x

12

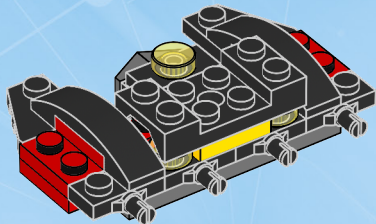





2x



1x

13

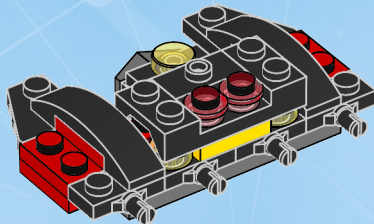



1x



2x

14

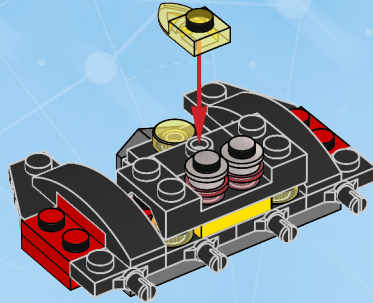



2x

15

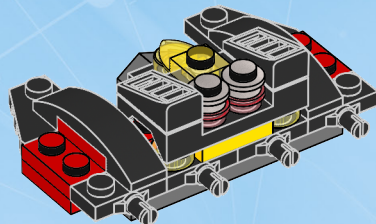



3x

16

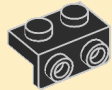

3x

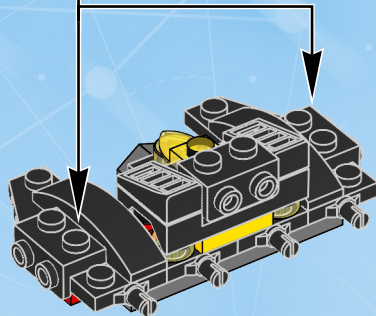



17

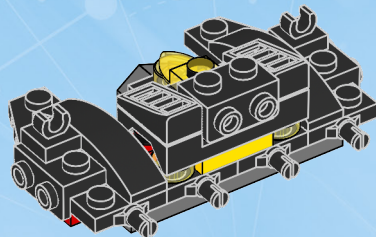



1x



2x

18

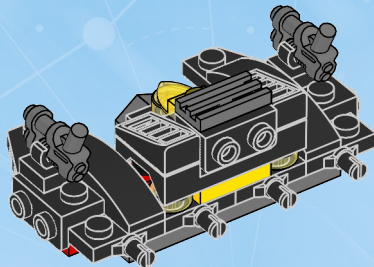



1x



1x

# 19

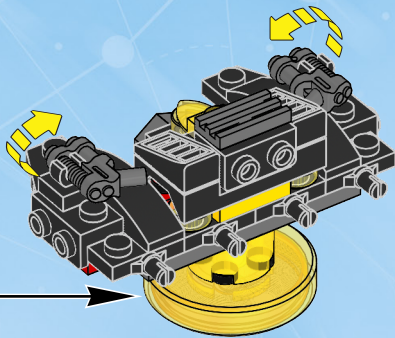
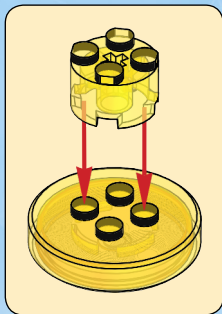



4x



4x

20



4x

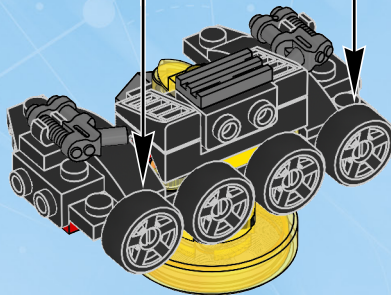





2x



2x

21

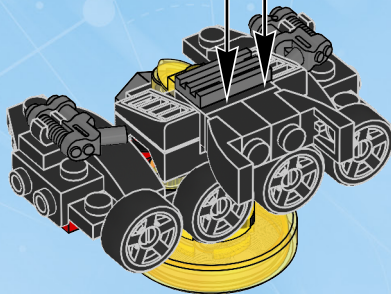
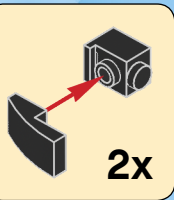

LEGO DIMENSIONS Videogame software © 2017 TT Games Ltd. Produced by TT Games under license from the LEGO Group. LEGO, the LEGO logo, NINJAGO, the NINJAGO logo, DIMENSIONS, the DIMENSIONS logo, the Brick and Knob configurations and the Minifigure are trademarks and/or copyrights of the LEGO Group. ©2017 The LEGO Group. Ghostbusters™ & © 2017 CPII. All Rights Reserved. A-Team™ & © 2017 Twentieth Century Fox Film Corporation. All Rights Reserved. ADVENTURE TIME and all related characters and elements are trademarks of and © Cartoon Network. (s17). TM, ® & ©2017 Paramount Pictures. All Rights Reserved. ©2017 Warner Bros Entertainment Inc. All Rights Reserved. Harry Potter and Fantastic Beasts Publishing Rights © JKR. (s17). © SEGA. All rights reserved. GREMLINS © &™ WBEI (s17).™ & © Universal Studios. E.T. THE EXTRA TERRESTRIAL is a trademark and copyright of Universal Studios. Licensed by Universal Studios Licensing LLC. All DC characters and related indicia™ & © DC Comics.™ & © WBEI. (s17). All other trademarks and copyrights are the property of their respective owners. All rights reserved.

Logiciel de jeu vidéo LEGO DIMENSIONS © 2017 TT Games Ltd. Produit par TT Games avec l'autorisation de LEGO Group. LEGO, le logo LEGO, NINJAGO, le logo NINJAGO, DIMENSIONS, le logo DIMENSIONS, les configurations de la Brique et du Bouton, ainsi que le Minifigure sont des marques de commerce ou des droits d'auteur de LEGO Group. ©2017 The LEGO Group. Ghostbusters™ et © 2017 CPII. Tous droits réservés. A-Team™ et © 2017 Twentieth Century Fox Film Corporation. Tous droits réservés. ADVENTURE TIME et tous personnages et éléments associés sont des marques de commerce et droits d'auteur de Cartoon Network. (s17).™, ® et ©2016 Paramount Pictures. Tous droits réservés. ©2017 Warner Bros Entertainment Inc. Tous droits réservés. Droits d'édition sur Harry Potter et Les Animaux fantastiques © JKR. (s17). © SEGA. Tous droits réservés. GREMLINS © et™ WBEI (s17).™ et © Universal Studios. E.T. L'EXTRA-TERRESTRE est une marque de commerce d'Universal Studios, qui en détient également les droits d'auteur. Autorisé par Universal Studios Licensing LLC. Tous les personnages DC et indices associés sont des marques de commerce et © de DC Comics.™ et © WBEI. (s17). Toutes les autres marques de commerce et droits d'auteur sont la propriété de leurs propriétaires respectifs. Tous droits réservés.

LEGO DIMENSIONS Videogame software © 2017 TT Games Ltd. Producido por TT Games con licencia de LEGO Group. LEGO, el logotipo de LEGO, NINJAGO, el logotipo NINJAGO, DIMENSIONS, el logotipo de DIMENSIONS, las configuraciones Brick y Knob y la Minifigura son marcas de fábrica y/o derechos de autor de LEGO Group. ©2017 The LEGO Group. Ghostbusters es™ y © 2017 de CPII. Todos los derechos reservados. A-Team es™ y © 2017 de Twentieth Century Fox Film Corporation. Todos los derechos reservados. ADVENTURE TIME y todos los personajes y elementos relacionados son marcas registradas y © de Cartoon Network. (s17).™ es® y © de 2017 Paramount Pictures. Todos los derechos reservados. ©2017 Warner Bros Entertainment Inc. Todos los derechos reservados. Harry Potter y Animales Fantásticos Derechos de publicación © JKR. (s17). © SEGA. Todos los derechos reservados. GREMLINS es© y™ de WBEI (s17).™ y © de Universal Studios. E.T. THE EXTRA TERRESTRIAL es una marca registrada y los derechos de autor son de Universal Studios. Con licencia de Universal Studios Licensing LLC. Todos los personajes y elementos relacionados de DC son™ y © de DC Comics.™ y © de WBEI. (s17). Todas las marcas comerciales y los derechos de autor son propiedad de sus respectivos titulares. Todos los derechos reservados.



WB GAMES LOGO, WBIE LOGO, WB SHIELD:™ & © Warner Bros. Entertainment Inc.  
LOGO WB GAMES, LOGO WBIE, BOUCLIER WB :™ et © de Warner Bros. Entertainment Inc.  
LOGOTIPO de WB GAMES, LOGOTIPO de WBIE, ESCUDO de WB:™ & © Warner Bros.  
Entertainment Inc.  
(s17)



All DC characters and related indicia™ & © DC Comics.™ & © WBEI.  
Tous les personnages DC et toutes les marques associées™ et © DC Comics.™ et © WBEI.  
Todos los personajes de DC e indicios relacionados™ & © DC Comics.™ & © WBEI.  
(s17)

THE LEGO MOVIE © The LEGO Group & WBEI.  
LE FILM LEGO © The LEGO Group et WBEI.  
LA GRAN AVENTURA LEGO © The LEGO Group & WBEI.

© New Line.™ & © SZC lic. to WBIE.  
© New Line.™ et © SZC lic. à WBIE.  
© New Line.™ & © SZC con licencia de WBIE.  
(s17)